

Company Profile

More Interactive Education

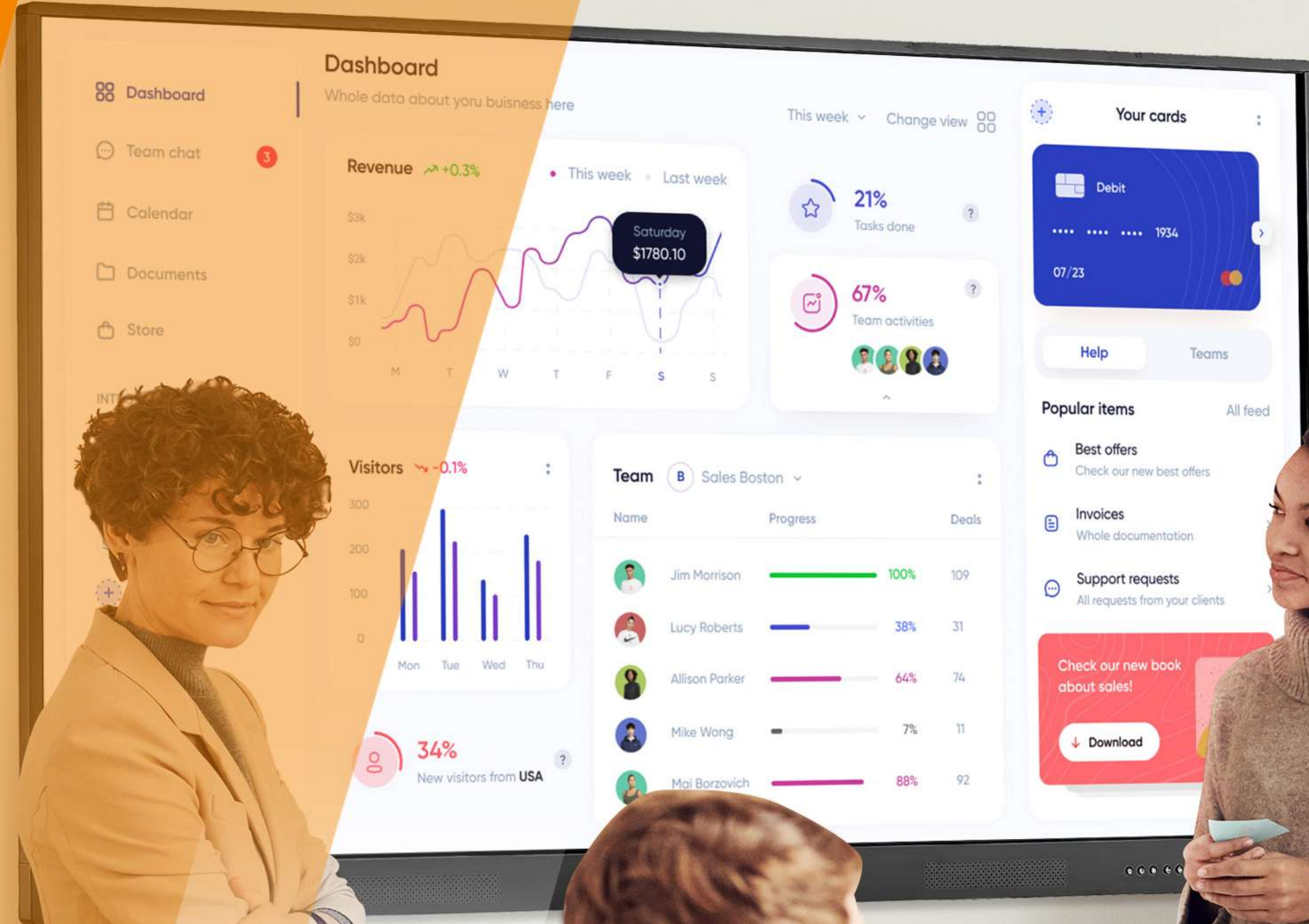

»»» **Contents** «««

01.

Products

02.

Screen Design

03.

Operating System

04.

Certificate

01

Product Introduction

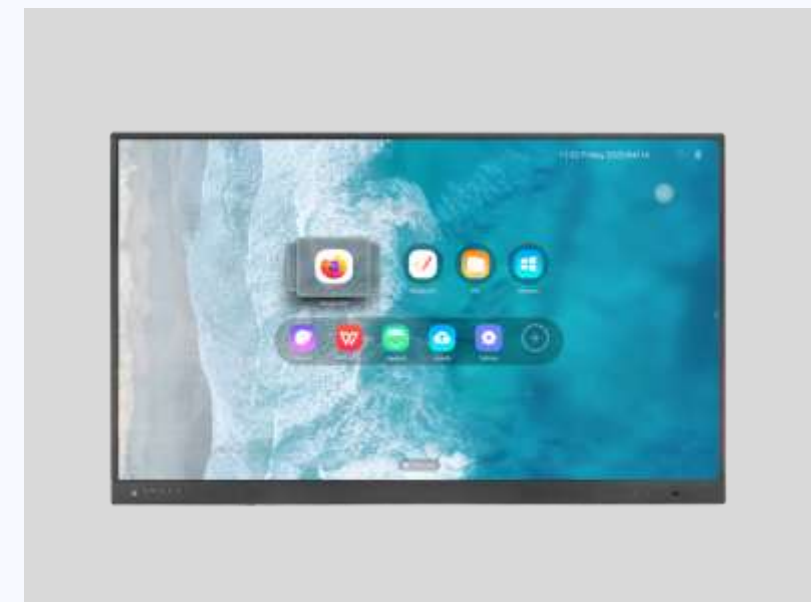
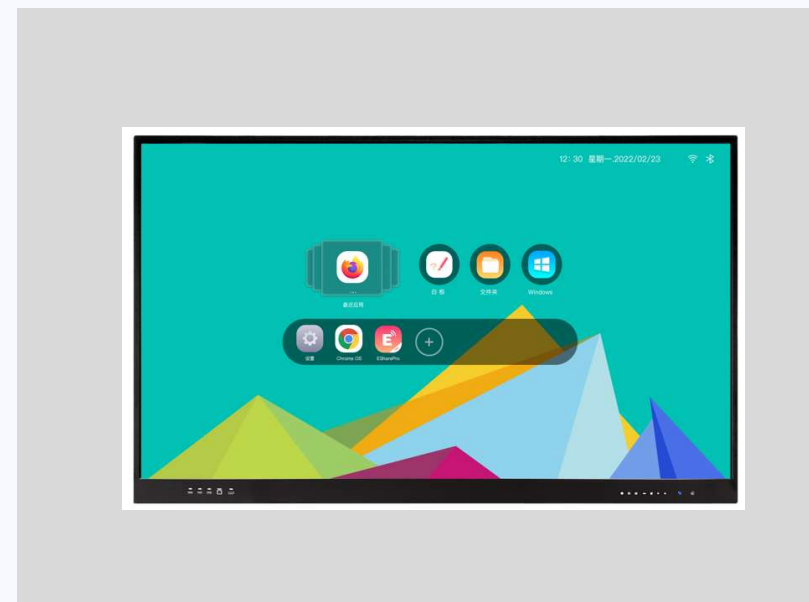

Android 13.0

Android 12.0

Android 11.0

Android + Window



Interactive Panel Series

• Sizes: 65" | 75" | 86" | 98" | 105" | 110"



Standard



Education

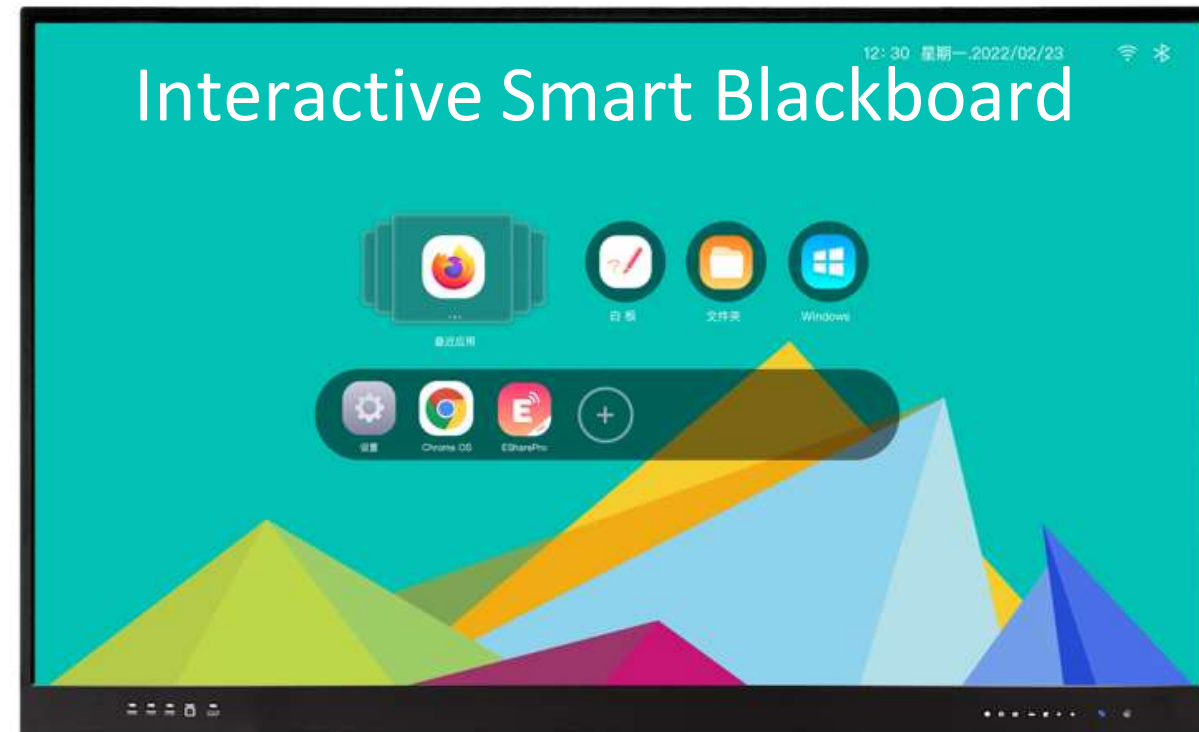

Business



Built-in Camera

NFC

Finger Print



M Smart Blackboard



(Pcap Touch/Foldable)

Green/Black/White Boards for IR IFPD

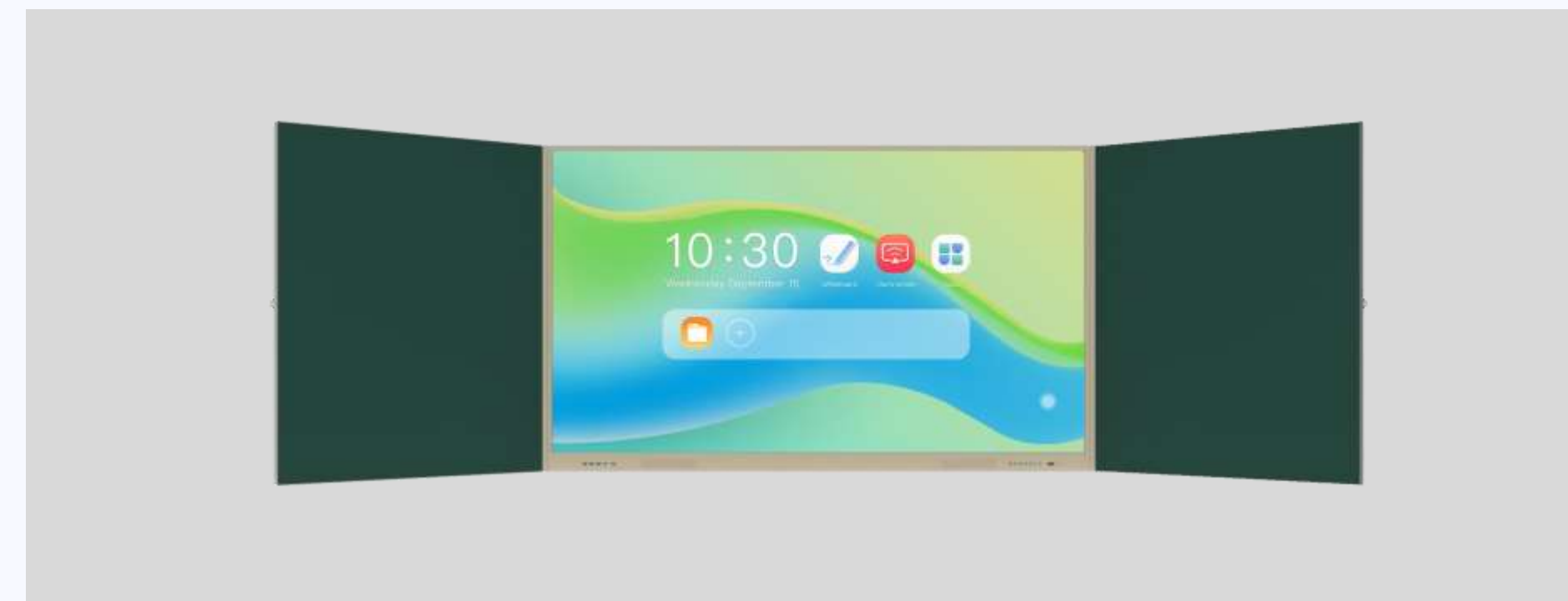

(IR Touch/Foldable)

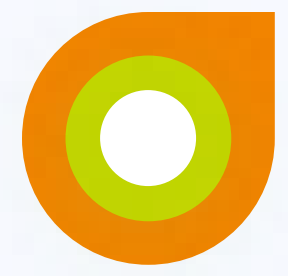

Smart Blackboard

- Sizes: 75 inch | 86 inch



- Foldable, Easy Installation

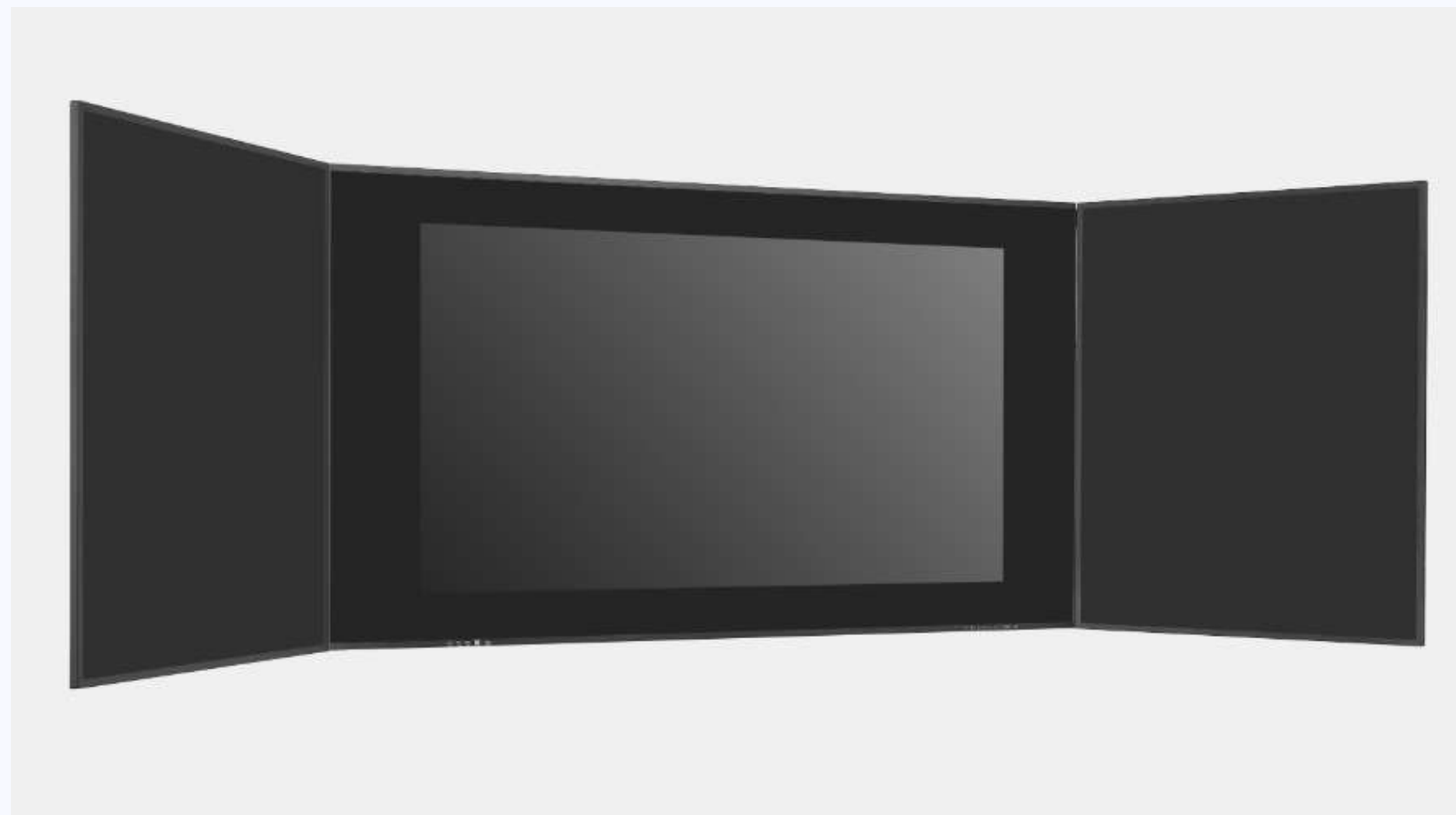

- Front side Connectivity

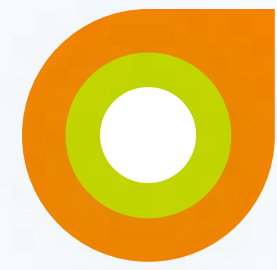

Product Range



- 1 65" /75" /86" /98" /110" Wings
- 2 Green/Black/White wings
- 3 Green/Black/White wings
- 4 Double side writing boards
- 5 Writings from board shows on screen simultaneously(Optional)

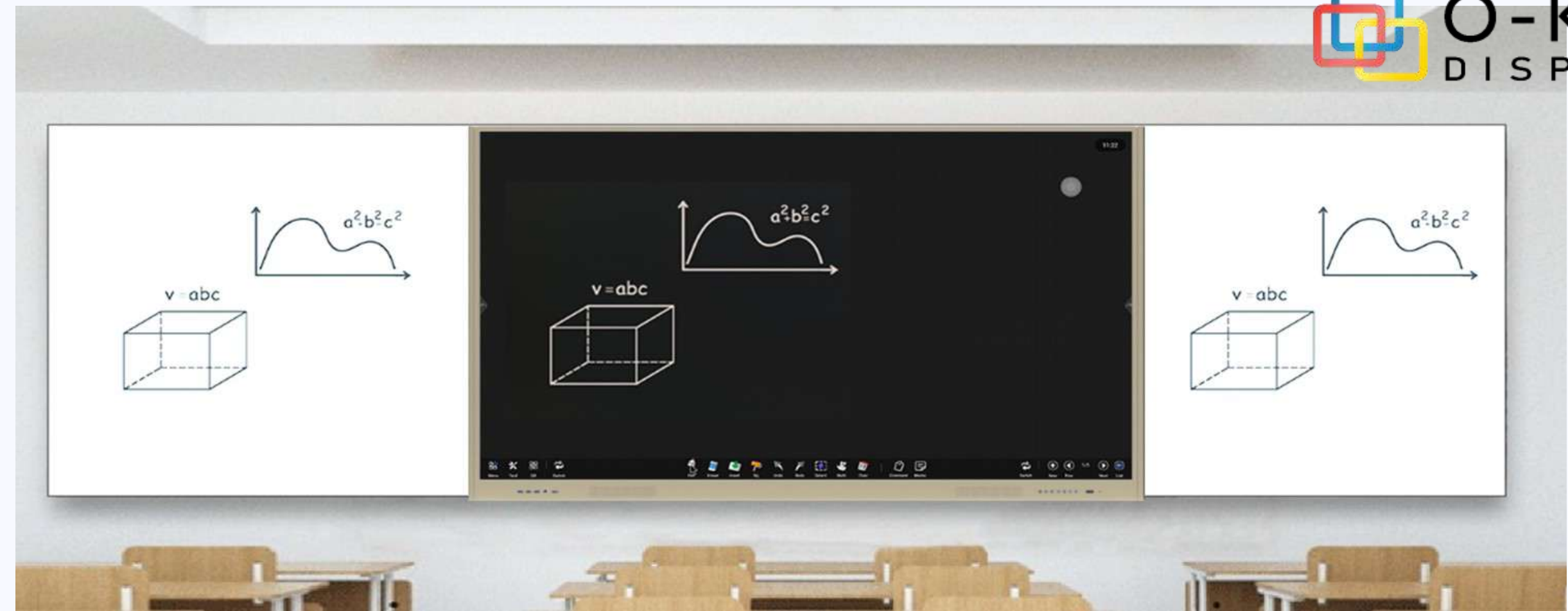

Folden Green/black/white Board Wings for IR IFPD



Foldable Green/black/white Board Wings



● Foldable Design with Locking Plate

● Easy Joints and Installation

- 1 Core i3/i5/i7
- 2 10th, 11th, 12th Generation
- 3 RAM: 8GB/16GB/32GB
- 4 Storage: 256GB/512GB/1T

Standard OPS



EU Standard OPS



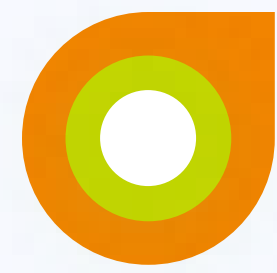

Interactive Whiteboards

Interactive Whiteboard

P-IWB

S-IWB

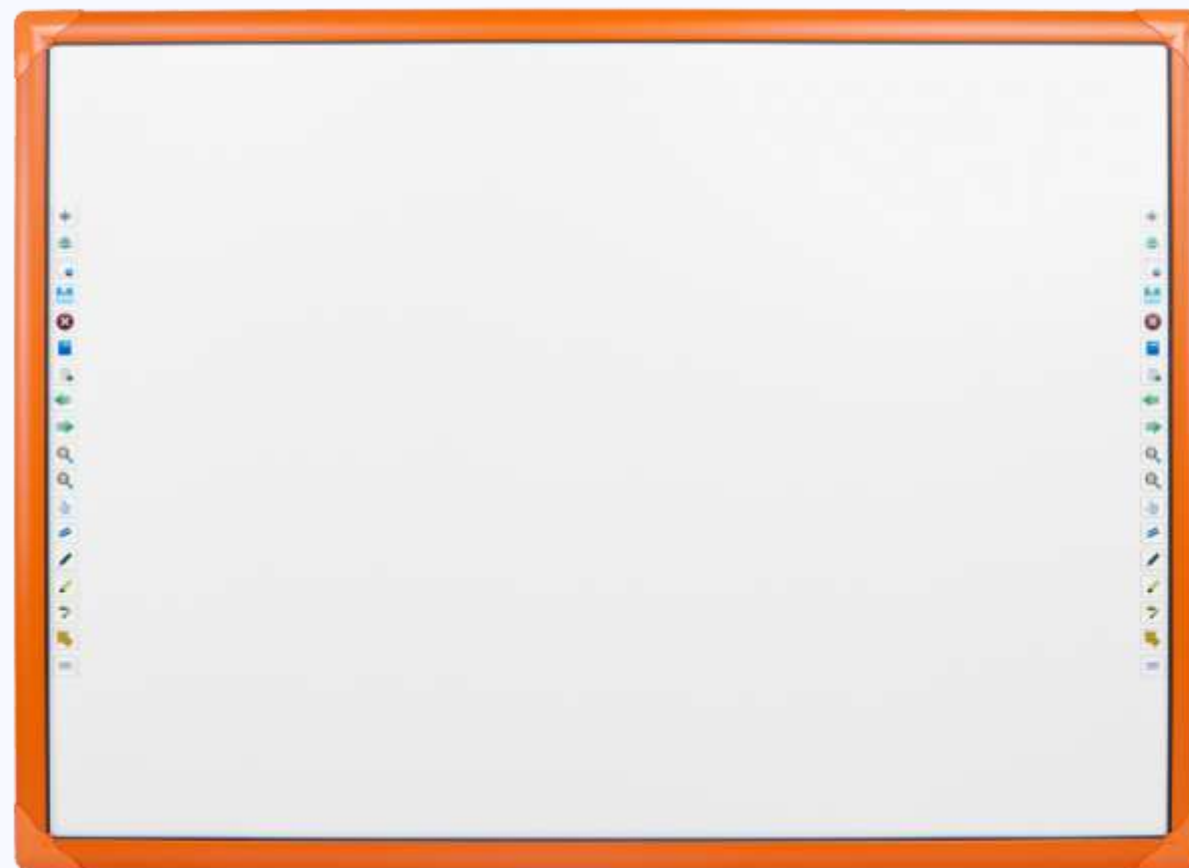

● S series(Aluminum frame)



• Elegant Slim Frame

• Multiple Shortcut Keys

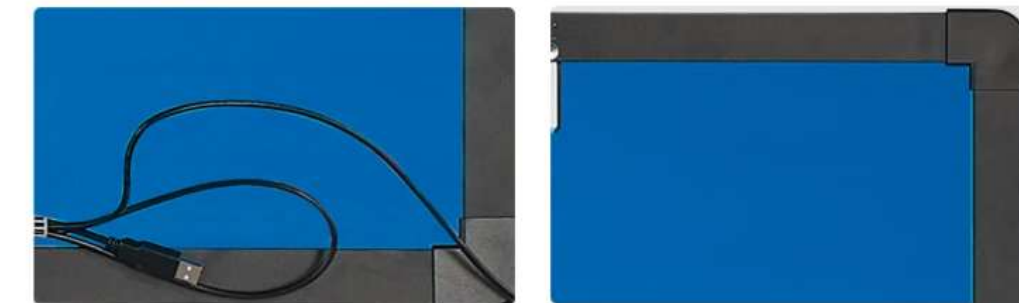

• USB Plug and Play

• Smooth Surface Nano Board

● P series(ABC Plastic frame)



• Elegant Slim Frame

• Multiple Shortcut Keys



• USB Plug and Play

• Smooth Surface Nano Board

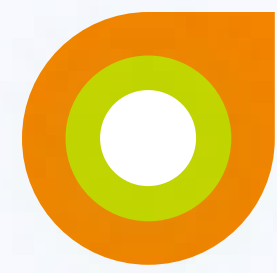

Product Range-Accessories

MeetingPod



4KUHD Camera
60W Speaker
120° Wild View Angle

Super Mobile Stand



180KG Heavy Bearing
Suitable for 100" -110" IFP

Mobile Stand



Suitable for 55" -86" IFP

OPS



02

Screen Structure Design



Structure ID

ID Design

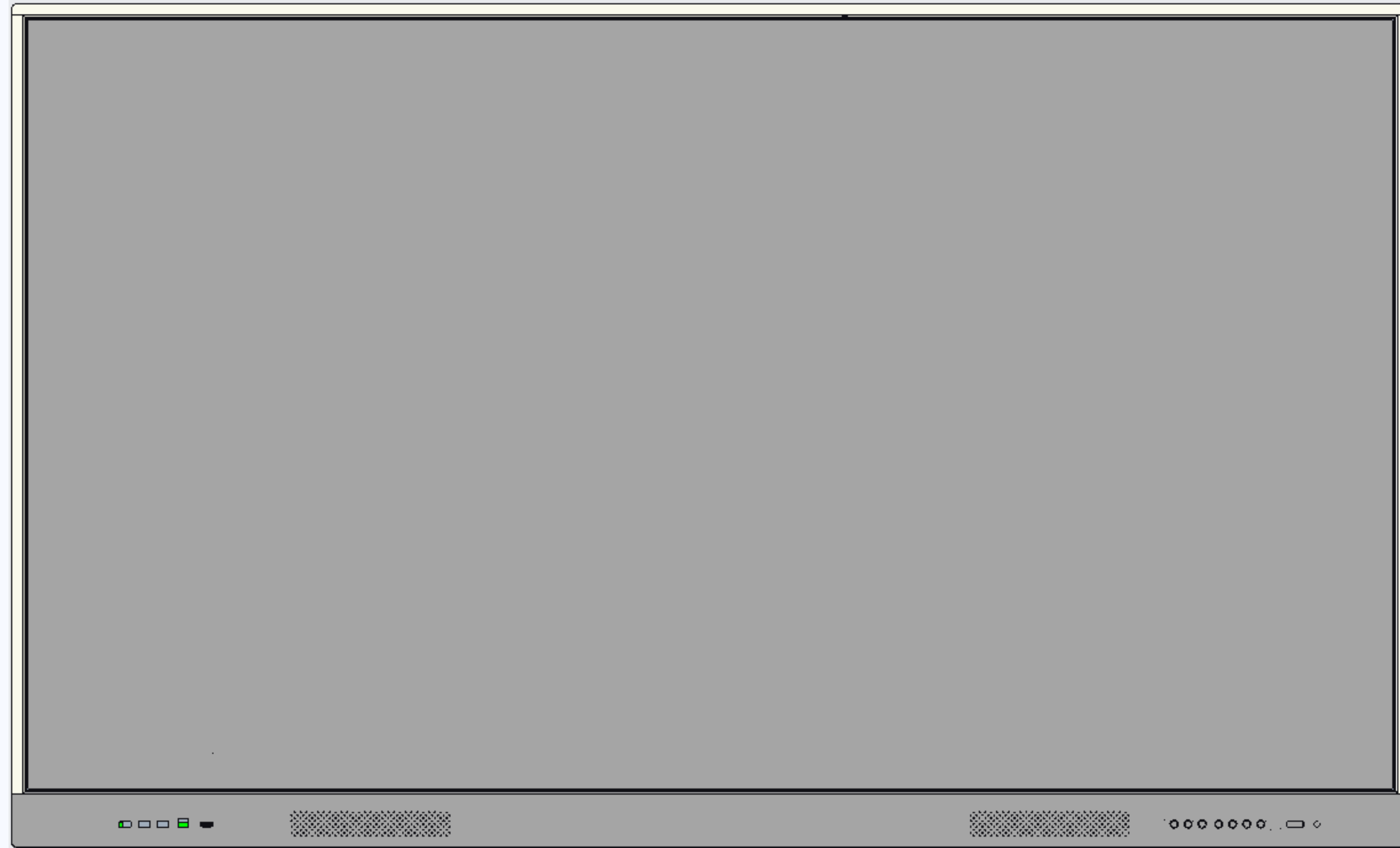
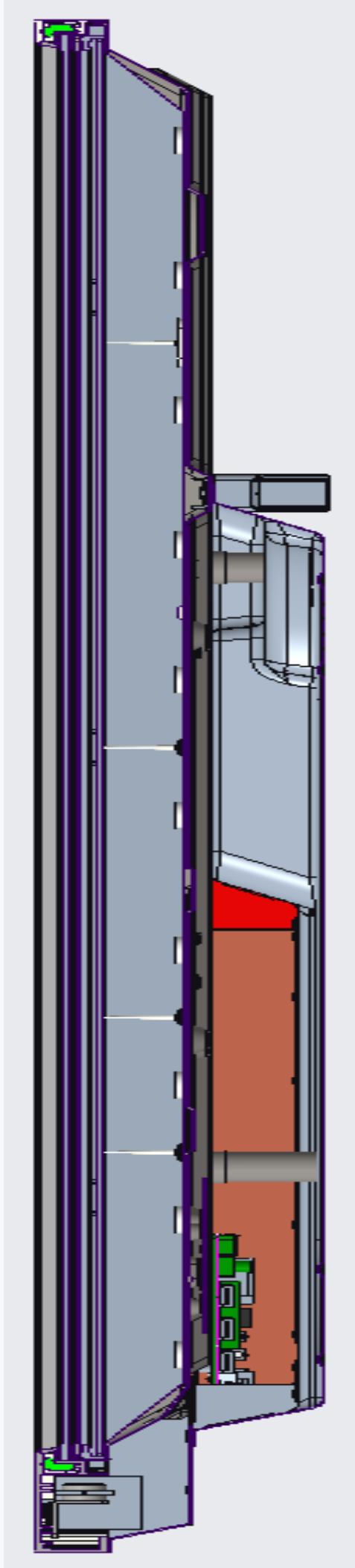

Standard Series

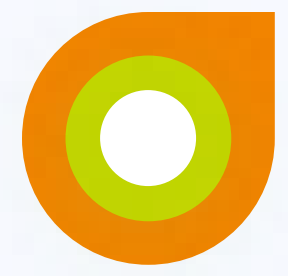

Structure ID

ID Design

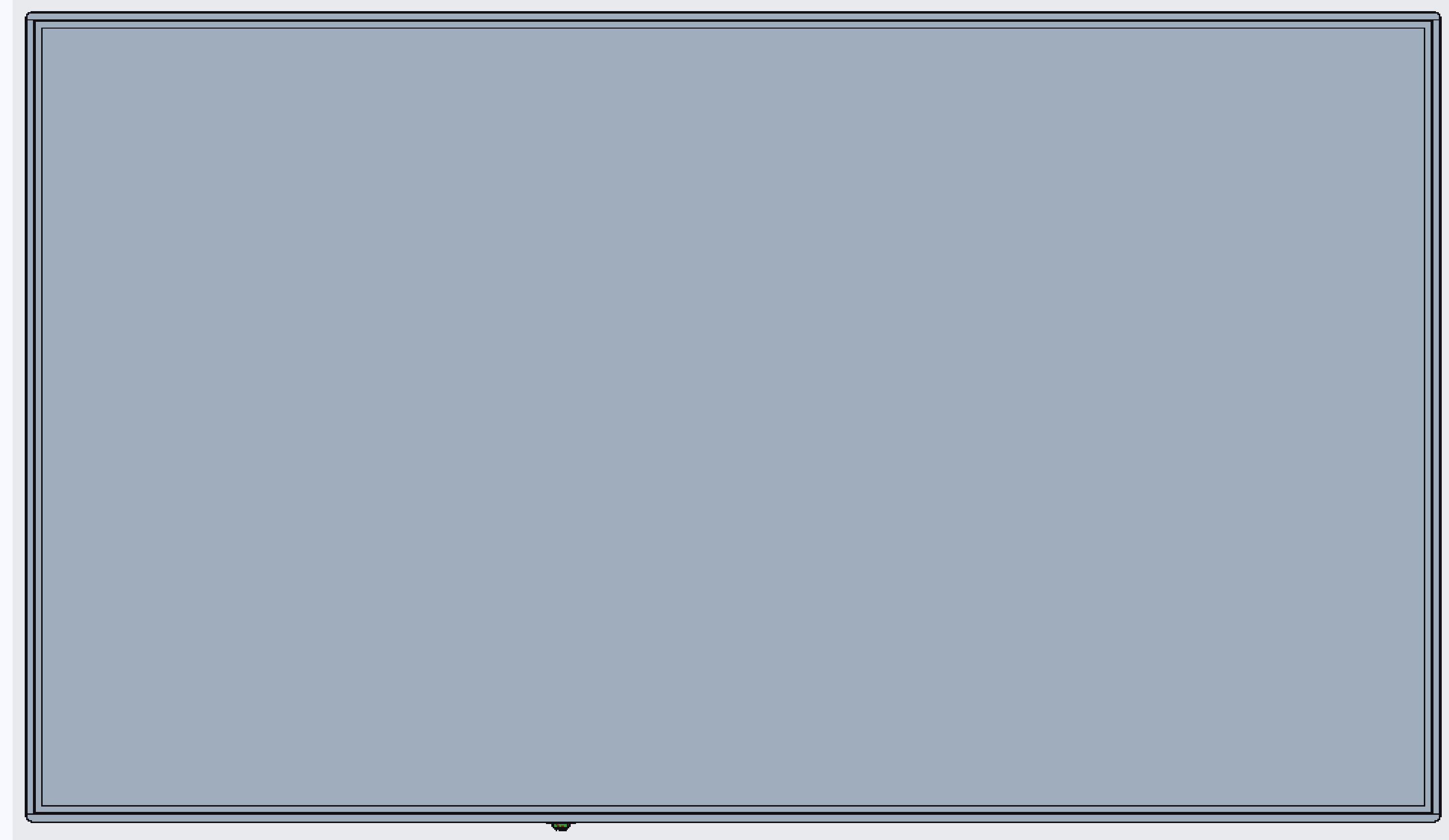
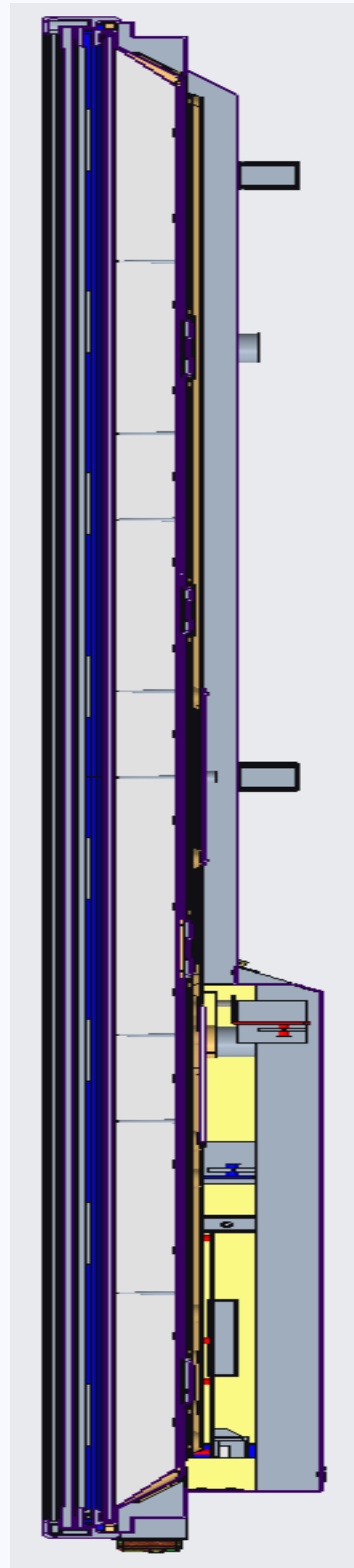

Education Series



Structure ID

ID Design

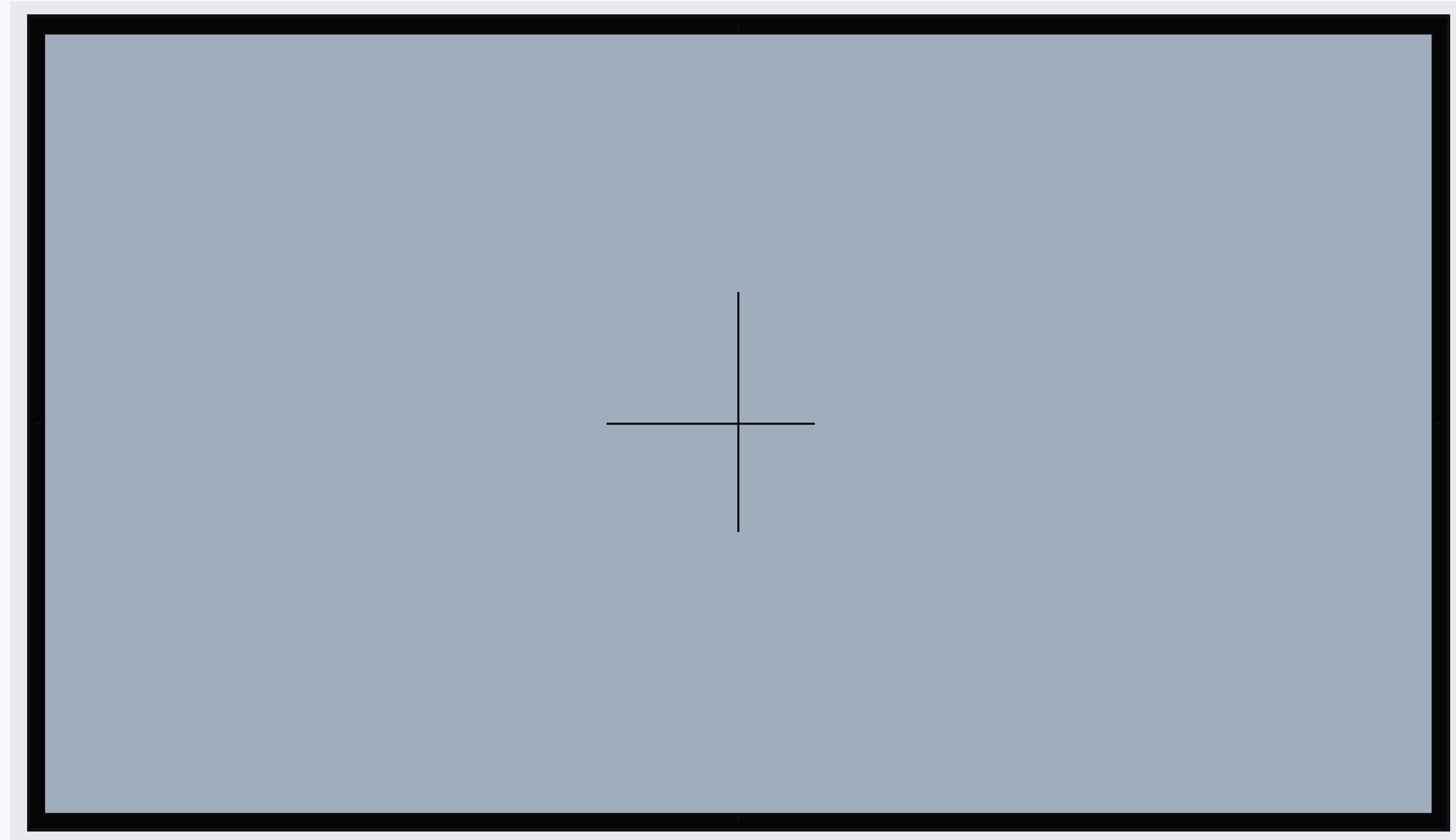

Business Series



Mainboards & Interfaces Design



ADV311D2

982V1 & 982V2

ADV560

ADV811

ADV100

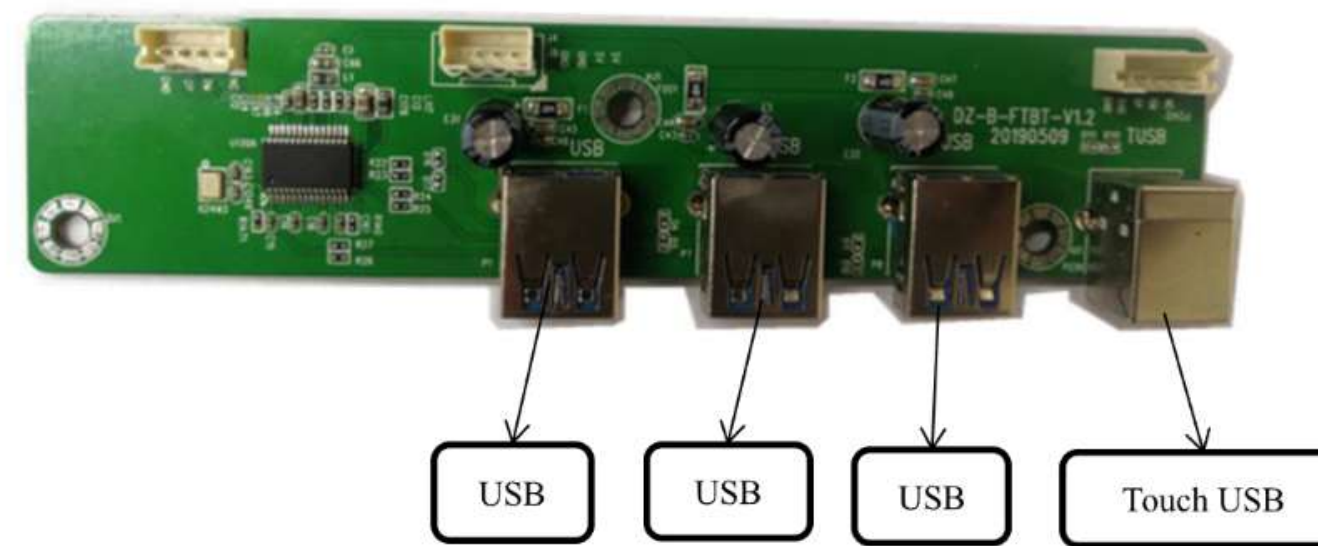
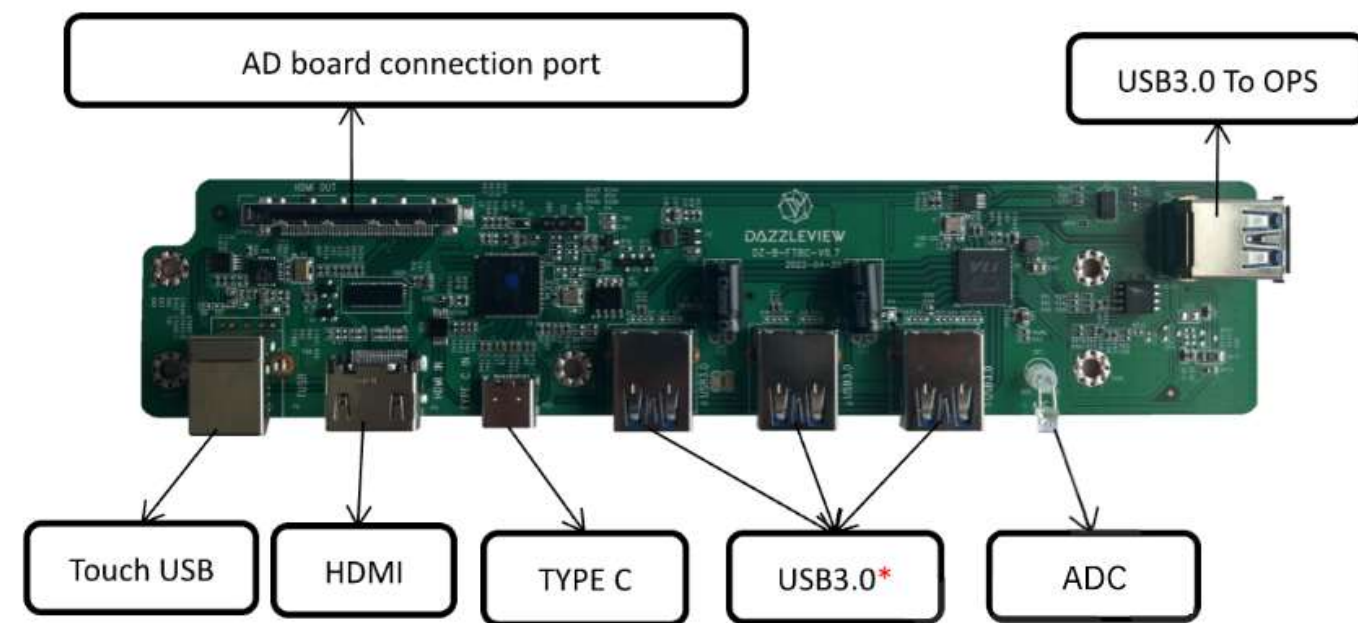

03

Operating System

OS Solution-Launcher



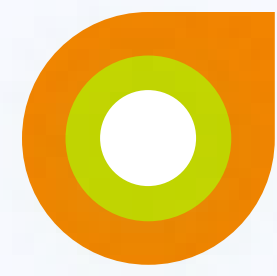

Whiteboard Functions for Android & Windows

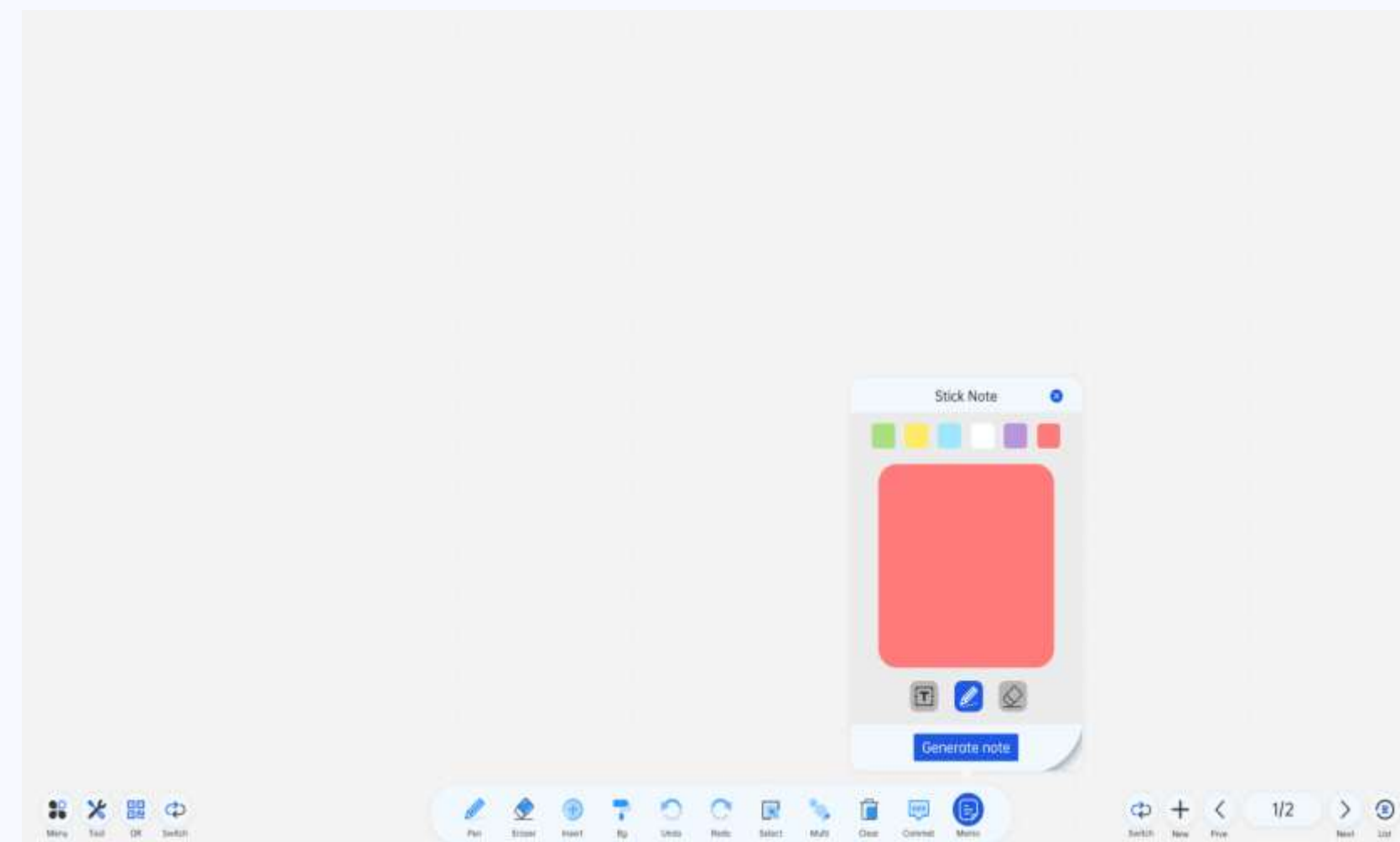
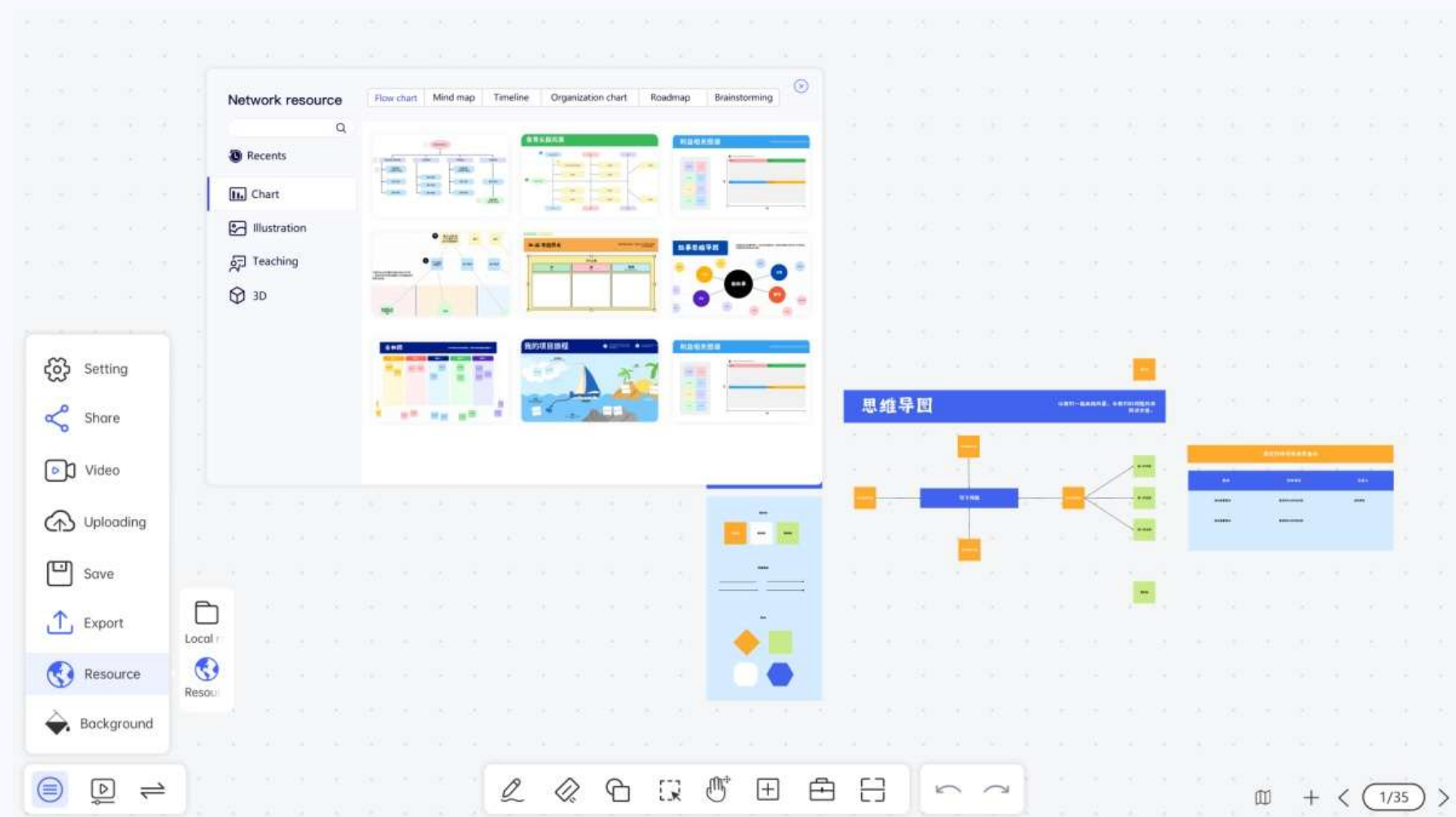
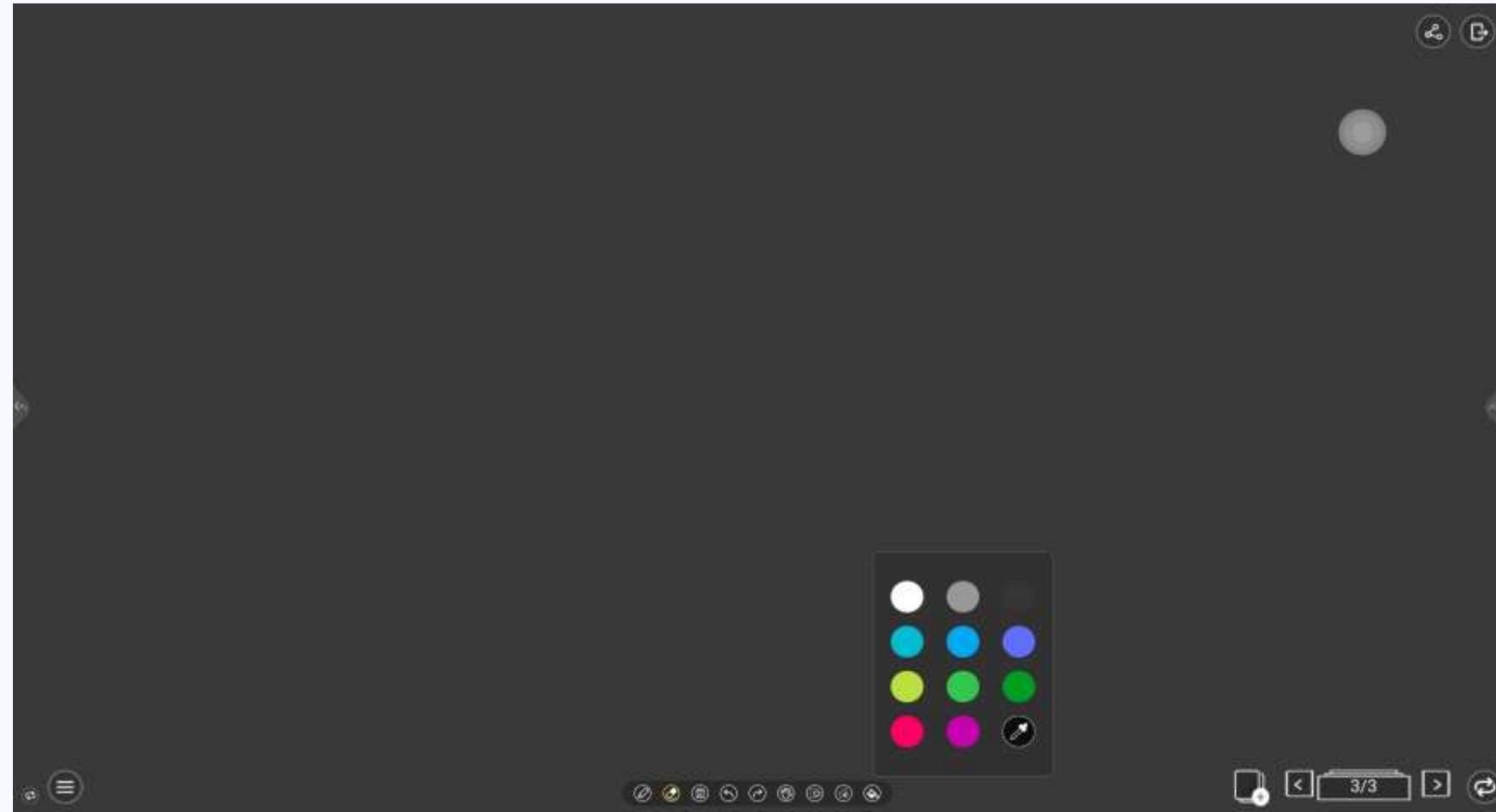

New Functions

- Smart Search
- Insert videos
- Upload file
- Multiple Tools
- Dual Pen



UVideoShow UPictureShow UVip UPlay UPicture

VIP application



Play Store Appstore

Appstore



ZOOM Skype Microsoft Teams Google meet Webex Assemblr Academia Canvas Student Edu Career Institute edX

Third-party application



Other Equipment Integration



Document Camera



Podium



Broadcast Speakers



Charging Cart

04

Certificate



Certificate



● CE

● ISO



● Certificate of honor



● Energy conservation

● FCC

● ROHS

● CCC

● Quality test



● Certificate of honor

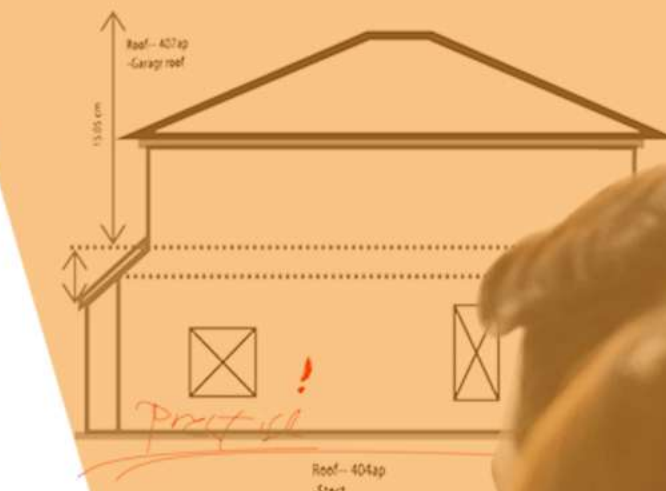
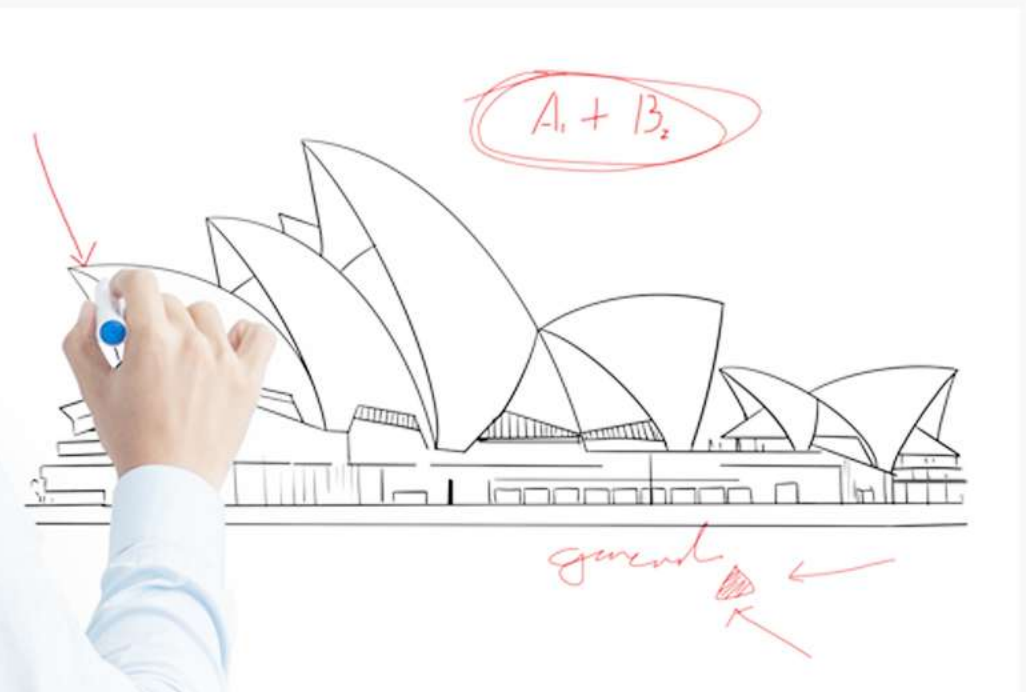

THANK
YOU